

Article number: 203180M1675B3U

Description: E+G levelling foot

GN 31-80-M16-75-B3-U

Note: U Without nut, Hexagon socket at the top, Wrench flat at the bottom

Measures

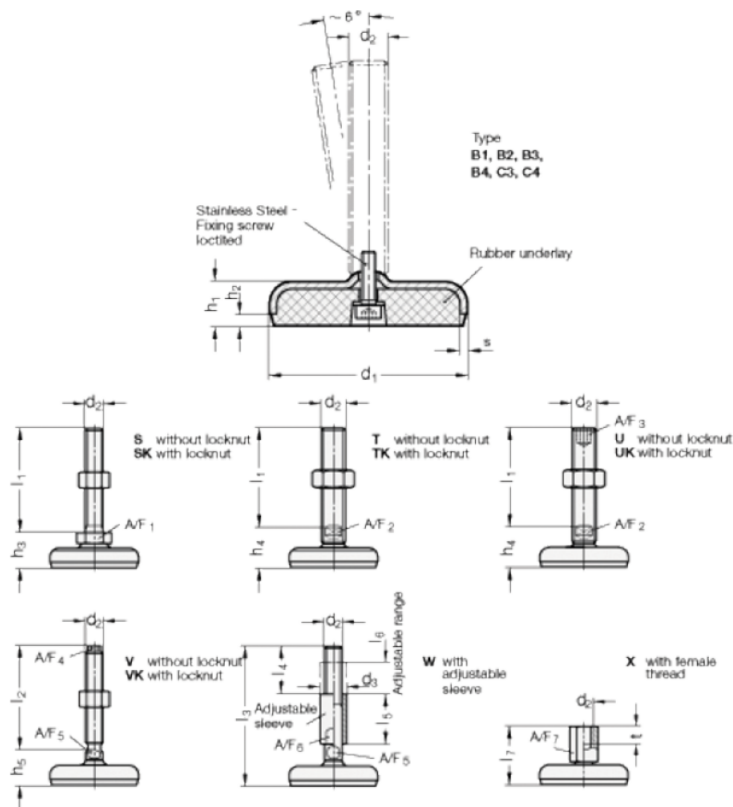

A/F2	= 12	s = 3
A/F3	= 8	
d1	= 80	
d2	= 16	
h1	= 18	
h2	= 5	
h4 +4.0/0	= 32	
l1	= 75	